









INSTALLATION INSTRUCTIONS - INSTRUCCIONES DE INSTALACIÓN CLAD SLIDING PATIO DOOR - SOUTHWESTERN WALL WITH HARD COAT STUCCO PUERTA PARA PATIO CORREDIZA, PARA PARED ESTILO SUREÑO CON ESTUCO DE CAPA BASE

Lea las instrucciones en español en el reverso.







Installation Instructions for Typical Wood Frame Construction.

These instructions were developed and tested for use with typical wood frame wall construction in a wall system designed to manage water. **These instructions are not to be used with any other construction method.** Installation instructions for use with other construction methods, multiple units or bow and bay windows, may be obtained from Pella® Corporation or a local Pella retailer. Building designs, construction methods, building materials, and site conditions unique to your project may require an installation method different from these instructions and additional care. Determining the appropriate installation method is the responsibility of you, your architect, or construction professional.

YOU WILL NEED TO SUPPLY:

- Cedar or Impervious shims/spacers (12 to 20) 
- 2" galvanized roofing nails (1/4 lb.) 
- Closed cell foam backer rod/sealant backer (12 to 30 ft.) 
- Pella® SmartFlash™ foil backed butyl window and door flashing tape or equivalent 
- High quality exterior grade polyurethane or silicone sealant (2 to 3 tubes per door) 
- Great Stuff™ Window and Door Insulating Foam Sealant by the Dow Chemical Company or equivalent low pressure polyurethane window and door foam - DO NOT use high pressure or latex foams. 
- Pella aluminum sill support or 2 x 4 wood blocking
- Interior trim and/or jamb extensions (15 to 40 ft.)
- 9" wide Fortifiber flashing paper or equivalent

TOOLS REQUIRED:

- Tape measure 
- 6' Level 
- Square 
- Hammer 
- Stapler 
- Sealant gun 
- Scissors or utility knife 
- Drill 
- Screwdrivers (#2 Phillips with 8" shaft and small flat blade) 

REMEMBER TO USE APPROPRIATE PERSONAL PROTECTIVE EQUIPMENT.

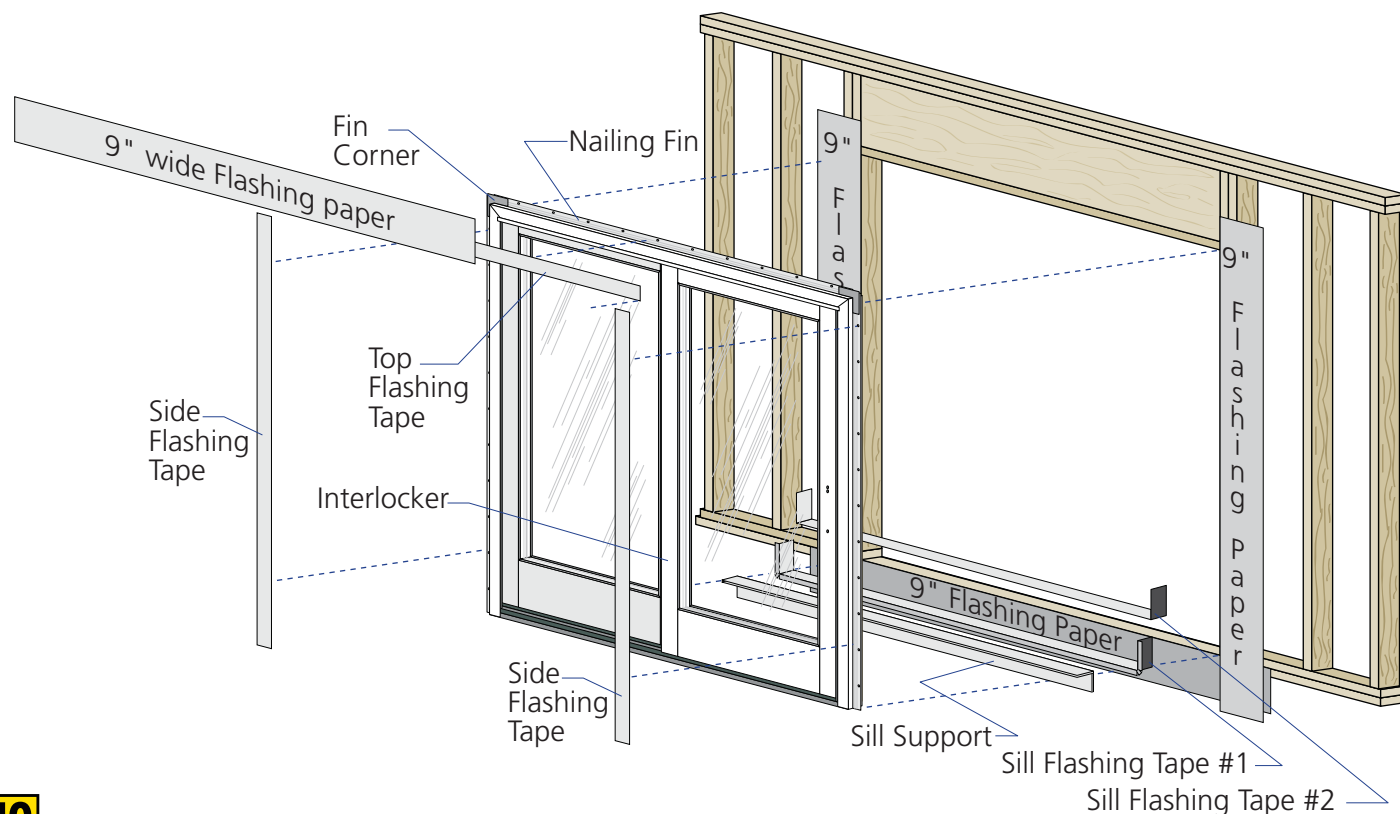

Always read the Pella® Limited Warranty before purchasing or installing Pella products. By installing this product, you are acknowledging that this Limited Warranty is part of the terms of the sale. Failure to comply with all Pella installation and maintenance instructions may void your Pella product warranty. See Limited Warranty for complete details at <http://warranty.pella.com>.

1 ROUGH OPENING PREPARATION

A. Confirm the opening is plumb and level.

Note: It is critical that the bottom is level.

B. Confirm the door will fit the opening. Measure all four sides of the opening to make sure it is 3/4" larger than the door in width and 1/2" larger in height. Measure the width at the top, bottom, and center. Measure the height at the far left side, the far right side, and in the center.

Note: 1-1/2" or more of solid wood blocking is required around the perimeter of the opening. Fix any problems with the rough opening before proceeding.

C. Apply flashing paper at the bottom (1C). Cut one piece of flashing paper 18" longer than the width of the rough opening. Position the top edge of the flashing paper with the top of the sill plate. Center the flashing paper with the opening width. Staple the flashing paper to the sill plate.

Note: Bottom flashing paper is not required for installation on concrete floors.

D. Apply flashing paper to the sides of the rough opening (1D). Cut two pieces of flashing paper 18" longer than the height of the rough opening. Apply one piece to each jamb. Position the edge of the flashing paper with the inside edge of the trimmer (jack stud), and center the flashing paper with the height of the rough opening. Staple the flashing paper to the trimmer.

E. Apply bottom flashing tape #1. Cut a piece of flashing tape 12" longer than the opening width. Apply at the bottom of the opening as shown (1E) so it overhangs 1" to the exterior.

Note: The tape is cut 12" longer than the width of the opening so that it will extend up each side approximately 6".

F. Tab the bottom flashing tape and fold. Cut 1" wide tabs at each corner (1/2" from each side of corner) (1F). Fold tape to the exterior and press firmly to adhere it to the flashing paper.

G. Apply bottom flashing tape #2. Cut a piece of flashing tape 12" longer than the opening width. Apply at the bottom, overlapping tape #1 by at least 1". DO NOT allow the tape to extend past the interior face of the framing (1G).

Note: The flashing tape does not need to extend all the way to the interior of the framing.

H. Attach the aluminum sill support or wood blocking to the exterior of the box plate to support the edge of the door sill. Place the sill support flush with the subfloor.

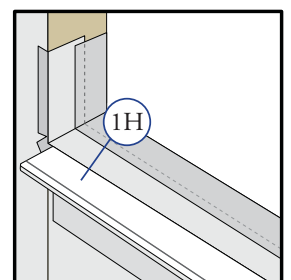
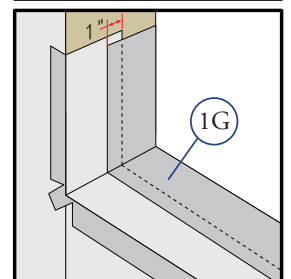
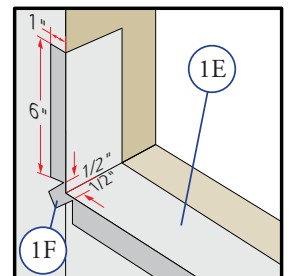
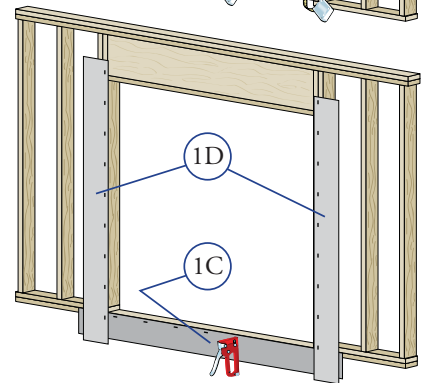
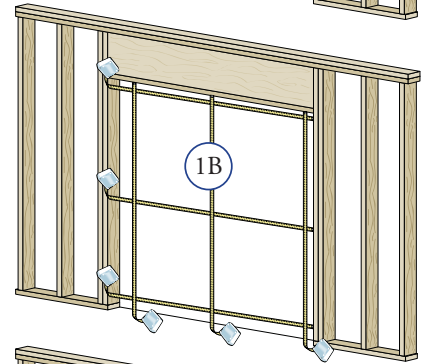
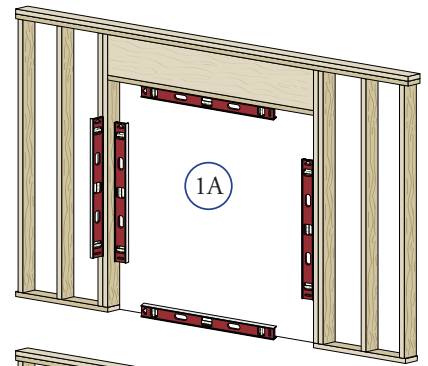

2 PREPARE THE DOOR FOR INSTALLATION

- A. **Remove the plastic wrap and cardboard packaging** from the door.

Note: If screens, grilles or hardware are removed from the door at this time, label them and store them in a protected area.

- B. **Remove the shipping spacers.** Carefully slide the movable panel halfway open and remove the spacers from both the top and bottom of the movable panel.

TWO OR MORE PEOPLE WILL BE REQUIRED TO HANDLE THE PANEL & FRAME SAFELY.

- C. **Remove the venting panel** by lifting it out of the lower track and tilting the bottom of the panel away from the door frame. Then, lower the panel out of the top track. Carefully set the panel aside.

Note: Assemble the OXXO frame per the instructions included with the door splice kit.

- D. **Fold out installation fin to 90°.** Be careful not to remove or tear the fin corners.

Note: If the fin is not at 90°, the door will not line up correctly on the interior.

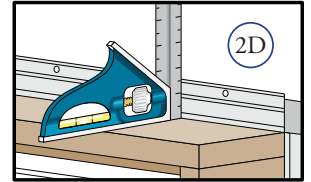

3 SETTING AND FASTENING THE DOOR

- A. **Place three 3/8" beads of sealant.** The first bead should be approximately 3/4" from the exterior of the rough opening, the second 2-1/2" in from the first bead of sealant. Place a third bead of sealant in the groove of the sill support or 1/4" from the exterior edge of the wood blocking.

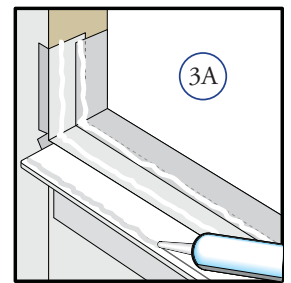

TWO OR MORE PEOPLE WILL BE REQUIRED FOR THE FOLLOWING STEPS.

- B. **Insert the door** from the exterior of the building. **DO NOT** slide the bottom of the door into the opening. Sliding will damage the sealant lines. Place the bottom of the door at the bottom of the opening, then tilt the top into position. Center the door between the sides of the opening to allow equal clearance for shimming, and insert one roofing nail in the first hole from the corner on each end of the top nailing fin. These are used to hold the door in place while shimming it plumb and square.

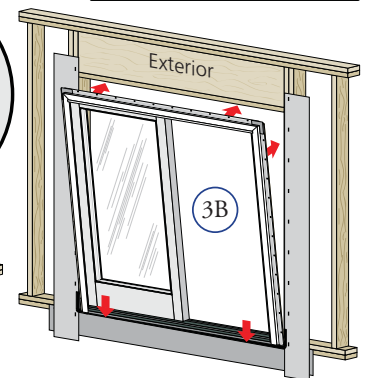
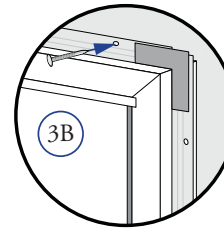

- C. **Plumb and square door.** Insert shims, as necessary, between the door and the sides of the rough opening starting up 6" from the bottom of the door.

Note: DO NOT OVER SHIM.

- D. **Check the interior reveal.** Make sure the measurement from the interior face of the door to the interior face of the wall is equal at several points around the door.

Note: If the dimensions are not equal, check to make sure the fins are folded out to 90° at all points.

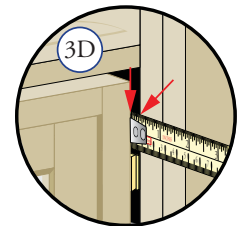
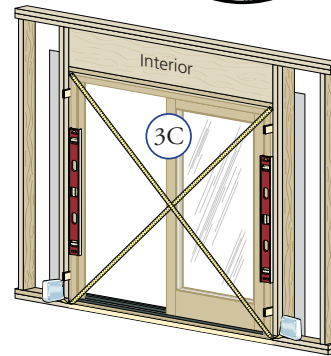

- E. **Secure the frame.** Insert a 1" wide shim behind the pilot hole at the lock strike(s). Insert a #8 x 2-1/2" screw (included in the panel retainer and screw package) into the pilot hole making sure it passes through the shim and into the rough opening.

Note: The weather strip must be pushed aside to reveal the pilot hole. Be careful not to damage the weather-strip. Architect Series® and Designer Series® have 2 lock strikes, ProLine® has one lock strike.

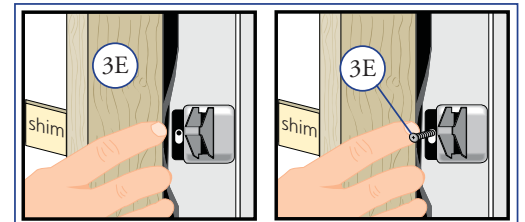

- F. **Fasten the door to opening** by driving 2" galvanized roofing nails into each pre-punched hole in the nailing fin.

Note: Make sure the fin corner is lying as flat as possible.

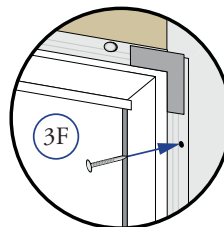

ProLine Doors - Proceed to Step 4.

3 SETTING AND FASTENING THE DOOR (continued)

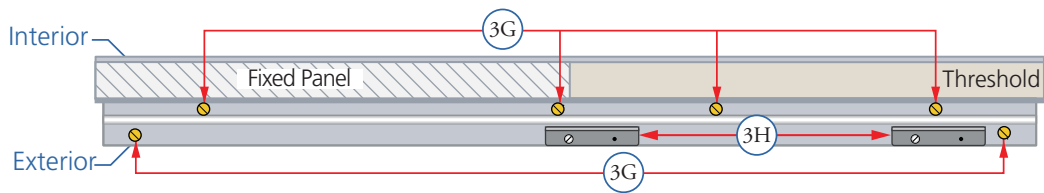

Architect Series and Designer Series

G. **Architect Series and Designer Series:** Apply sealant and insert a #8 x 2-1/2" screw (provided) into each hole in the bottom of the door frame (shown above in gold).

H. **Architect Series and Designer Series:** Position and secure the panel retainer by drilling pilot holes through the remaining holes in the retainer into the sill support or wood blocking, then apply sealant to the holes and insert a screw into each hole as specified below.

Aluminum sill support: 9/64" pilot holes, #10 x 3/4" thread cutting screws (provided).

Wood blocking: 1/8" pilot holes, #10 x 2-1/2" flat head wood screws (provided).

Masonry floor: 3/16" x 1-3/4" concrete screw. Pilot drill per screw manufacturer's recommendations.

I. **Remove the factory installed screws from the retainer** and repeat the process.

J. **Architect Series and Designer Series:** Drill a 3/16" clearance hole at each indentation in the extrusion at the top of the door frame into the rough opening, stopping when the drill is through the door frame. Apply sealant to each hole, then insert a #8 x 3" stainless steel screw into each hole.

4 INTEGRATING THE DOOR TO THE BUILDING FELT

Note: The flashing tape must be applied approximately 1/2" onto the frame cladding at the jambs and head. Pre-folding the tape 1/2" before removing the paper backing will make it easier to apply the tape correctly. If the siding is less than 1/2" thick, adjust the dimension of the fold so the exterior sealant line will cover the exterior edge of the tape.

A. **Apply side flashing tape.** Cut 2 pieces of flashing tape 4" longer than the frame height of the door. Apply one piece 1/2" up onto the frame cladding, over the nailing fin and onto the flashing paper to each side. The tape should extend 2" above the top of the door and 2" below the bottom of the door. Press the tape down firmly while folding down the excess tape at the top and bottom of the door.

B. **Apply top flashing tape.** Cut a piece of flashing tape long enough to go across the top of the door and extend at least 1" past the side flashing tape on both sides. Apply the tape 1/2" up onto the frame cladding, over the top nailing fin as shown. Fold the overlapping tape down, and press all tape down firmly.

Note: The top flashing tape must overlap the side flashing tape to prevent water from getting behind it.

C. **Apply the top flashing paper.** Cut one piece of flashing paper at least 21" longer than the width of the rough opening. Position the bottom edge of the flashing paper flush with the frame of the door and center the flashing paper with the width of the door. Staple the flashing paper to the header.

Note: When applying the first layer of building felt, ensure the sill flashing paper overlaps the building felt. This will tie the door system into the building water management system.

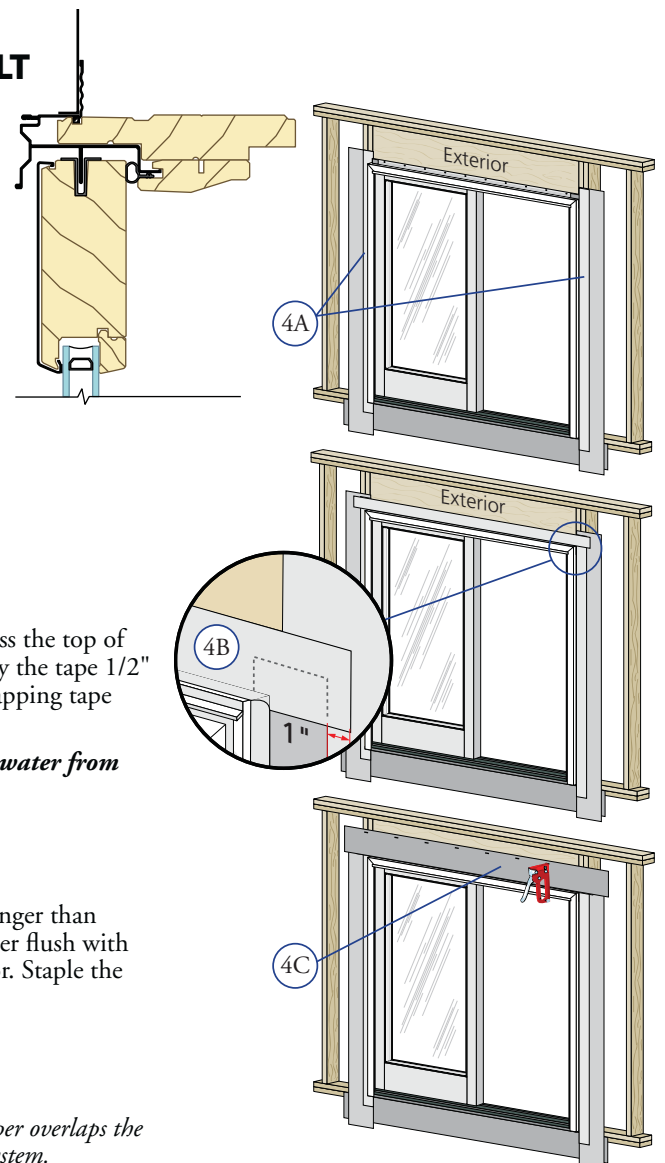

5 REINSTALL THE SLIDING PANEL

TWO OR MORE PEOPLE WILL BE REQUIRED TO HANDLE THE PANEL SAFELY.

- A. **Insert door panel.** From the exterior of the building, tilt the top of the panel toward the door frame and insert the top of the door panel into the top track. Move the bottom of the panel toward the door frame until it is vertical. Gently set the panel down into the bottom track.

Architect Series: Adjust the panel clip and tighten the panel clip screw.

ProLine only: Install bumpers and the panel retainer. Follow the instructions included in the hardware box.

Note: Be careful not to pinch your fingers between the two panels. DO NOT close the sliding panel until you have installed the hardware. The door may lock when closed.

- B. **Install the handles and panel retainer.** Follow the instructions included in the hardware box. If the panel is not square to the door frame, adjust the bottom rollers by removing the adjusting hole cover and inserting an 8" long #2 Phillips screwdriver into the hole. Turn clockwise to raise the panel and counter-clockwise to lower the panel. Follow the instructions included in the handle box for final adjustments.
- C. **Install screen.** Instructions for installing the screen are found in the screen door package.

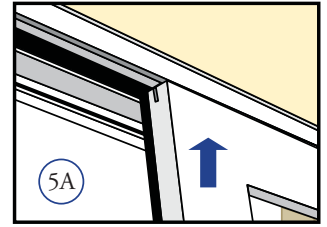

6 INTERIOR SEAL

Caution: Ensure use of low pressure polyurethane window and door installation foams and strictly follow the foam manufacturer's recommendations for application. Use of high pressure foams or improper application of the foam may cause the door to bow and hinder operation. DO NOT use fiberglass insulation.

- A. **Apply insulating foam.** From the interior, insert the nozzle of the applicator approximately 1" deep into the space between the door and the rough opening and apply a 1" deep bead of foam. This will allow room for expansion of the foam and will minimize squeeze out. If using foam other than Great Stuff™ Window and Door Insulating Foam Sealant by the Dow Chemical Company, allow the foam to cure completely (usually 8 to 24 hours) before proceeding to the next step.

Note: DO NOT completely fill the space from the back of the fin to the interior face of the opening.

- B. **Check the door operation** by opening and closing the door.

Note: If the door does not operate correctly, check to make sure it is still plumb, level, square and that the sides are not bowed. If adjustments are required, remove the foam with a serrated knife. Adjust the shims, and reapply the insulating foam sealant.

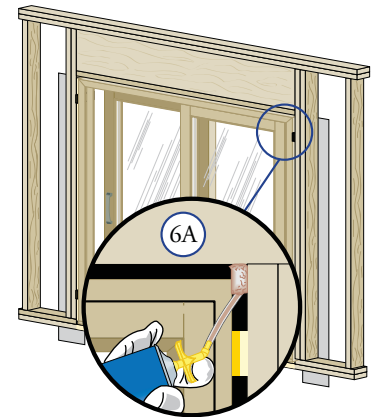

7 SEALING THE DOOR TO THE EXTERIOR WALL CLADDING

Note: When applying the casing bead for stucco, leave 1/2" space between the head of the door and the casing bead, and 3/8" space between the door jambs and the casing bead for backer rod and sealant. Refer to the illustration (Southwestern Wall With Stucco).

Note: The sealant details shown are standard recommendations from the sealant industry. Contact your sealant supplier for recommendations and instructions for this and any other application.

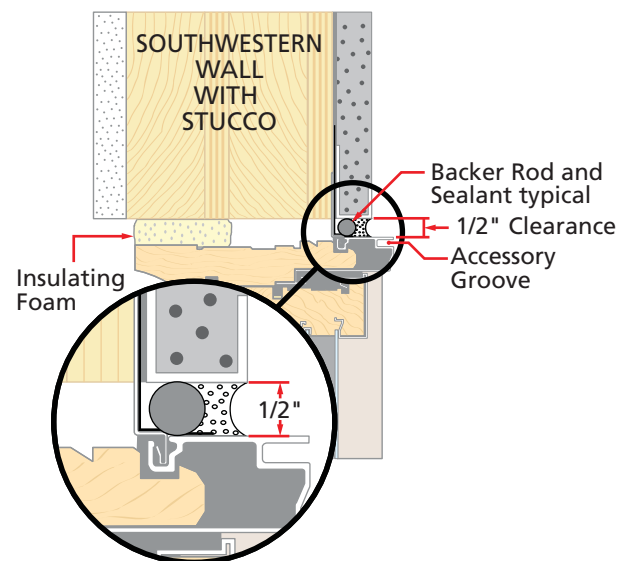

7 SEALING THE DOOR TO THE EXTERIOR WALL CLADDING (continued)

- A. **Insert backer rod into the space around the door** leaving at least a 1/2" clearance between the backer rod and the exterior face of the casing bead.

Note: Backer rod adds shape and depth for the sealant line.

- B. **Apply a bead of high quality exterior grade sealant** to the entire perimeter of the door. At each end of the bottom of the door, insert sealant into the spaces between the bottom of the door and the sill support and connect it to the perimeter sealant.

- C. **Shape, tool and clean excess sealant.** When finished, the sealant should be the shape of an hourglass.

Note: This method creates a more flexible sealant line capable of expanding and contracting.

- D. **Remove plastic guards** at the base of the door once construction is complete.

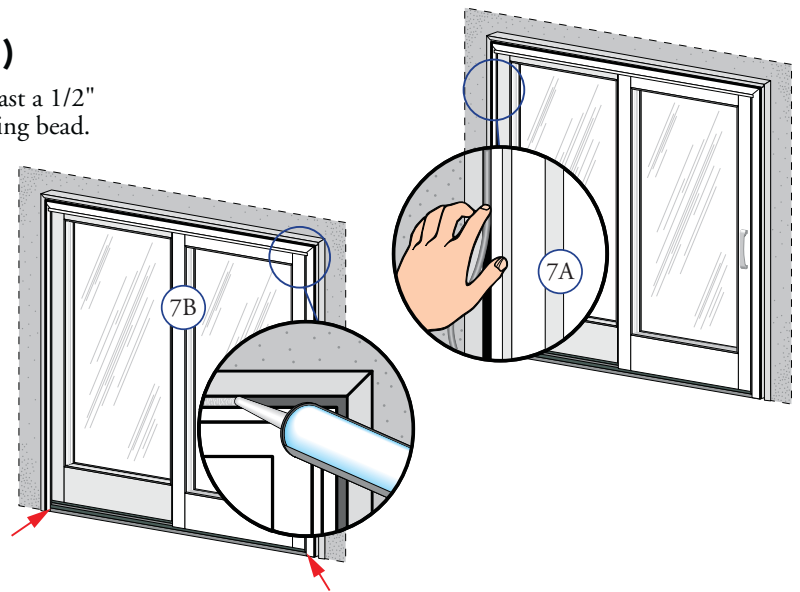

8 INTERIOR FINISHING

If the products cannot be finished immediately, cover with clear plastic to protect from dirt, damage and moisture. Remove any construction residue before finishing. Sand all wood surfaces lightly with 180 grit or finer sandpaper. **DO NOT** use steel wool. **BE CAREFUL NOT TO SCRATCH THE GLASS.** Remove sanding dust.

Pella products must be finished per the below instructions; failure to follow these instructions voids the Limited Warranty.

- On casement and awnings, it is optional to paint, stain or finish the vertical and horizontal sash edges.
- On single-hung and double-hung, do not paint, stain or finish the vertical sash edges, any finish on the vertical sash edges may cause the sash to stick; it is optional to paint, stain or finish the horizontal sash edges.
- On patio doors, it is optional to paint, stain or finish the vertical and horizontal panel edges.

Note: To maintain proper product performance do not paint, finish or remove the weather-stripping, mohair dust pads, gaskets or vinyl parts. Air and water leakage will result if these parts are removed. After finishing, allow venting windows and doors to dry completely before closing them.

Pella Corporation is not responsible for interior paint and stain finish imperfections for any product that is not factory-applied by Pella Corporation. Use of inappropriate finishes, solvents, brickwash, or cleaning chemicals will cause adverse reactions with window and door materials and voids the Limited Warranty.

For additional information on finishing see the Pella Owner's Manual or go to www.pella.com.

EXTERIOR FINISH

The exterior frame and sash are protected by aluminum cladding with our tough EnduraClad® or EnduraClad Plus baked-on factory finish that needs no painting. Clean this surface with mild soap and water. Stubborn stains and deposits may be removed with mineral spirits. **DO NOT** use abrasives. **DO NOT** scrape or use tools that might damage the surface.

Use of inappropriate finishes, solvents, brickwash or cleaning chemicals will cause adverse reactions with window and door materials and voids the Limited Warranty.

CARE AND MAINTENANCE

Care and maintenance information is available in the Pella Owner's Manual. You can obtain an owner's manual by contacting your local Pella retailer. This information is also available at www.pella.com.

IMPORTANT NOTICE

Because all construction must anticipate some water infiltration, it is important that the wall system be designed and constructed to properly manage moisture. Pella Corporation is not responsible for claims or damages caused by anticipated and unanticipated water infiltration; deficiencies in building design, construction and maintenance; failure to install Pella products in accordance with Pella's installation instructions; or the use of Pella products in wall systems which do not allow for proper management of moisture within the wall systems. The determination of the suitability of all building components, including the use of Pella products, as well as the design and installation of flashing and sealing systems are the responsibility of the Buyer or User, the architect, contractor, installer, or other construction professional and are not the responsibility of Pella.

Pella products should not be used in barrier wall systems which do not allow for proper management of moisture within the wall systems, such as barrier Exterior Insulation and Finish Systems, (EIFS) (also known as synthetic stucco) or other non-water managed systems. Except in the states of California, New Mexico, Arizona, Nevada, Utah, and Colorado, **Pella makes no warranty of any kind on and assumes no responsibility for Pella windows and doors installed in barrier wall systems. In the states listed above, the installation of Pella products in barrier wall or similar systems must be in accordance with Pella's installation instructions.**

Product modifications that are not approved by Pella Corporation will void the Limited Warranty.